

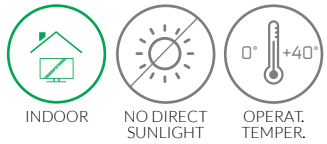

TACTIVE

TWI Wayfinding Kiosk



The Tactive TWI is an ultra-versatile kiosk thought out for interactive applications such as wayfinding, 3D map viewing and video catalogues. This is the perfect solution for shopping malls, museums, showrooms, or fairs. The landscape display has an integrated touch screen with 10 touches with an anti-scratch and anti-reflective 4mm glass, giving you speed and sensibility never seen before. The frontal panel can host devices such as webcam, card reader, barcode reader or 80mm thermal printer useful for market research. The double back panel on the other hand allows for immediate interventions and maintenance in a easy way.



- Major Features
- ERGONOMIC DESIGN
 - RUGGED BRUSHED STAINLESS STEEL FRAME
 - SUITABLE FOR SHOPPING MALLS
 - FULLY CUSTOMIZABLE
 - 24/7 USAGE
 - SMALL FOOTPRINT
 - 12 POINT PCAP TOUCHSCREEN
 - EASY ACCESS FOR MAINTENANCE

STRUCTURE AND MATERIALS





















- Structure in steel
- Front and back door
- Ergonomic design
- Safety Lock and invisible screws and hinges
- Custom frontal panel for various devices such as Printers, Card Reader and Webcam
- Small footprint

DISPLAY SIZES



OPTIONS

● Available ● Not Available ● Included ● On project

 CUSTOM COLOR	 AUDIO 2X5W	 TOUCH SCREEN	 UMTS-4G	 WI-FI	 BLUETOOTH	 WEBCAM	 MEDIA PLAYER	 CARD READER	 BARCODE READER
 CLIENT LOGO	 PROXIMITY IR SENSOR	 SHOCK SENSOR	 HVAC	 SOFTWARE	 ADVANCED DIAGNOSTIC	 BASE + WHEELS	 CASHLESS PAYMENT	 A4 THERMAL PRINTER	 80mm THERMAL PRINTER

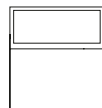
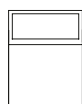

TECHNICAL SPECIFICATIONS

General

Product code	TWI.L43 (Landscape)	TWI.L49 (Landscape)
Screen size (inch)	43"	49"
Screen active area (cm)	95 X 54	107 X 60,4
Display brightness (nit)	380	420
Backlight technology	LEDedge	LEDedge
Screen resolution (pixel)	Full HD - 1920x1080	UHD - 3560x2160
Contrast ratio	1100:1 (typ)	1100:1 (typ)
Viewing angle (H/V)	178° / 178°	178° / 178°
Backlight Life cycle	50.000 hours	50.000 hours
System operation	24/7/365	24/7/365
Screen orientation	Landscape	Landscape
Screen side	Single	Single
Interactive touch	Projected capacitive 12t	Projected capacitive 12t
Environment protection	Indoor IP20 (Nema 1)	Indoor IP20 (Nema 1)
Operating temperature	0°C / +40°C	0°C / +40°C
Environment humidity	10% - 80%	10% - 80%
Antivandal protection	n.a.	n.a.
Air cooling system	n.a.	n.a.
Standard color	As shown below	As shown below
Enclosure material	Steel	Steel
Glass	Scratch-free glass (4mm)	Scratch-free glass (4mm)
Glass reflection	Anti-reflection	Anti-reflection
Vac supply	230V AC +/- 10	230V AC +/- 10
Power consumption (Typ)	75W	115W
Height (cm)	120	120
Width (cm)	107	121
Depth (cm)	65	65
Weight (Kg)	135	150

Environment

Enclosure

Dimensions Power

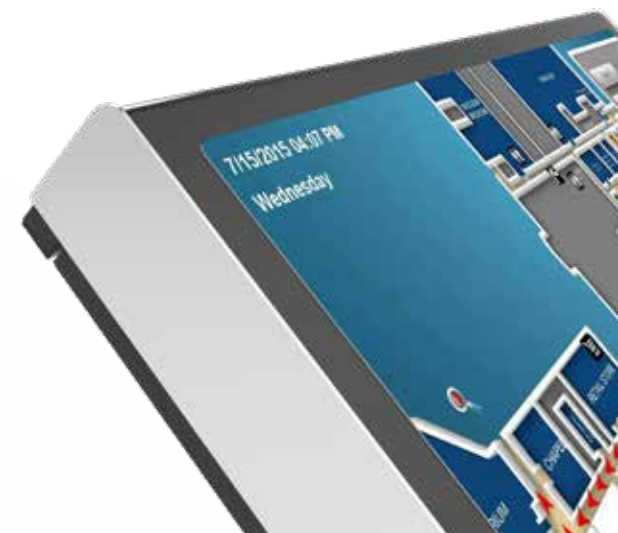
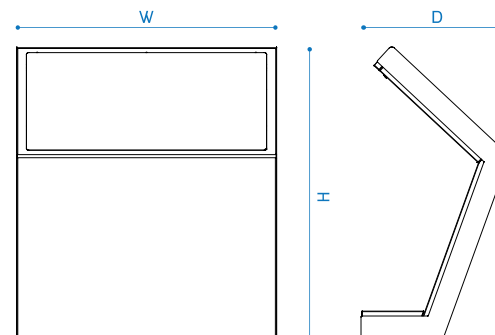

STANDARD COLORS AND FINISHING

Enclosure Colors ● Black RAL 9005
○ White RAL 9010
■ On request

Glass Colors ● Black RAL 9005
■ On request

TESTS AND CERTIFICATIONS

LVD 2014/35/UE
EMC 2014/30/UE
ROHS 2011/65/UE
IP Code IEC 60529
IK Rating IEC 62262

Safety of Information Technology Equipment:
IEC 60950-1
Safety Requirements of Audio, Video and Similar
Electronic Apparatus: IEC 60065

